

Relay Module - RIF-1-RSC-LDP-24DC/2X21MS - 2905660

Please be informed that the data shown in this PDF Document is generated from our Online Catalog. Please find the complete data in the user's documentation. Our General Terms of Use for Downloads are valid (<http://phoenixcontact.com/download>)



Pre-assembled relay module with screw connection, consisting of: relay base, relay retaining bracket, and power contact relay with test button, integrated status LED, and freewheeling diode. Contact type: 2 changeover contacts. Input voltage: 24 V DC

Product Description

The pluggable electromechanical and solid-state relays in the RIFLINE complete product range and the base are recognized and approved in accordance with UL 508. The relevant approvals can be called up at the individual components in question.



Key Commercial Data

| | |
|--------------------------------------|---|
| Packing unit | 10 pc |
| Minimum order quantity | 10 pc |
| GTIN |  4 055626 404820 |
| GTIN | 4055626404820 |
| Weight per Piece (excluding packing) | 68.000 g |
| Sales Key | CK6519 |

Technical data

Note

| | |
|-------------------------|---|
| Utilization restriction | EMC: class A product, see manufacturer's declaration in the download area |
|-------------------------|---|

Dimensions

| | |
|--------|-------|
| Width | 16 mm |
| Height | 89 mm |
| Depth | 75 mm |

Ambient conditions

| | |
|---|-------------------|
| Ambient temperature (operation) | -40 °C ... 60 °C |
| Ambient temperature (storage/transport) | -40 °C ... 85 °C |
| Degree of protection | IP20 (Relay base) |

Relay Module - RIF-1-RSC-LDP-24DC/2X21MS - 2905660

Technical data

Ambient conditions

| | |
|--|---------------|
| | RT II (Relay) |
|--|---------------|

Coil side

| | |
|---|---------------|
| Nominal input voltage U_N | 24 V DC |
| Input voltage range in reference to U_N | see diagram |
| Typical input current at U_N | 18 mA |
| Typical response time | 9 ms |
| Typical release time | 10 ms |
| Coil voltage | 24 V DC |
| Protective circuit | Damping diode |
| Operating voltage display | Yellow LED |
| Power dissipation for nominal condition | 0.43 W |

Contact side

| | |
|---------------------------------------|----------------------------|
| Contact type | 2 PDT |
| Type of switch contact | Single contact |
| Contact material | AgNi |
| Maximum switching voltage | 250 V AC/DC |
| Minimum switching voltage | 12 V (at 10 mA) |
| Min. switching current | 10 mA (at 12 V) |
| Maximum inrush current | 12 A (20 ms, N/O contacts) |
| Limiting continuous current | see diagram |
| Interrupting rating (ohmic load) max. | 192 W (at 24 V DC) |
| | 62 W (at 48 V DC) |
| | 42 W (at 60 V DC) |
| | 55 W (at 110 V DC) |
| | 66 W (at 220 V DC) |
| | 2000 VA (for 250 V AC) |
| Switching capacity min. | 120 mW |
| Switching capacity | 1 A (at 24 V, DC13) |
| | 1.5 A (at 24 V, AC15) |
| | 1.5 A (at 120 V, AC15) |
| | 1.5 A (at 240 V, AC15) |

General

| | |
|--|---------------------------------------|
| Test voltage relay winding/relay contact | 4 kV _{rms} (50 Hz, 1 min.) |
| Test voltage PDT/PDT | 2.5 kV _{rms} (50 Hz, 1 min.) |
| Operating mode | 100% operating factor |
| Flammability rating according to UL 94 | V2 (Housing) |
| Mechanical service life | approx. 5×10^6 cycles |
| Service life, electrical | see diagram |
| Mounting position | any |

Relay Module - RIF-1-RSC-LDP-24DC/2X21MS - 2905660

Technical data

General

| | |
|-----------------------|---------------------------|
| Assembly instructions | In rows with zero spacing |
|-----------------------|---------------------------|

Connection data

| | |
|---|--|
| Connection name | Coil side |
| Connection method | Screw connection |
| Stripping length | 8 mm |
| Conductor cross section solid | 0.5 mm ² ... 4 mm ² |
| Conductor cross-section solid (2 conductors with same cross section) | 0.5 mm ² ... 2.5 mm ² |
| Conductor cross section flexible | 0.5 mm ² ... 4 mm ² |
| | 0.5 mm ² ... 4 mm ² (Ferrule with plastic sleeve) |
| Conductor cross section flexible (2 conductors with same cross section) | 0.5 mm ² ... 2.5 mm ² |
| | 0.5 mm ² ... 1.5 mm ² (TWIN ferrule with plastic sleeve) |
| Conductor cross section AWG | 20 ... 10 (solid) |
| | 20 ... 12 (flexible) |
| Torque | 0.5 Nm ... 0.6 Nm |

Connection data 2

| | |
|---|--|
| Connection name | Contact side |
| Connection method | Screw connection |
| Stripping length | 8 mm |
| Conductor cross section solid | 0.5 mm ² ... 4 mm ² |
| Conductor cross-section solid (2 conductors with same cross section) | 0.5 mm ² ... 2.5 mm ² |
| Conductor cross section flexible | 0.5 mm ² ... 4 mm ² |
| | 0.5 mm ² ... 4 mm ² (Ferrule with plastic sleeve) |
| Conductor cross section flexible (2 conductors with same cross section) | 0.5 mm ² ... 2.5 mm ² |
| | 0.5 mm ² ... 1.5 mm ² (TWIN ferrule with plastic sleeve) |
| Conductor cross section AWG | 20 ... 10 (solid) |
| | 20 ... 12 (flexible) |
| Torque | 0.5 Nm ... 0.6 Nm |

Standards and Regulations

| | |
|--------------------------|----------------|
| Standards/regulations | DIN EN 50178 |
| Rated insulation voltage | 250 V AC |
| Rated surge voltage | 6 kV |
| Insulation | safe isolation |
| Pollution degree | 2 |
| Overvoltage category | III |

Environmental Product Compliance

| | |
|------------|---|
| China RoHS | Environmentally Friendly Use Period = 50 years |
| | For details about hazardous substances go to tab "Downloads", Category "Manufacturer's declaration" |

Relay Module - RIF-1-RSC-LDP-24DC/2X21MS - 2905660

Drawings

Circuit diagram

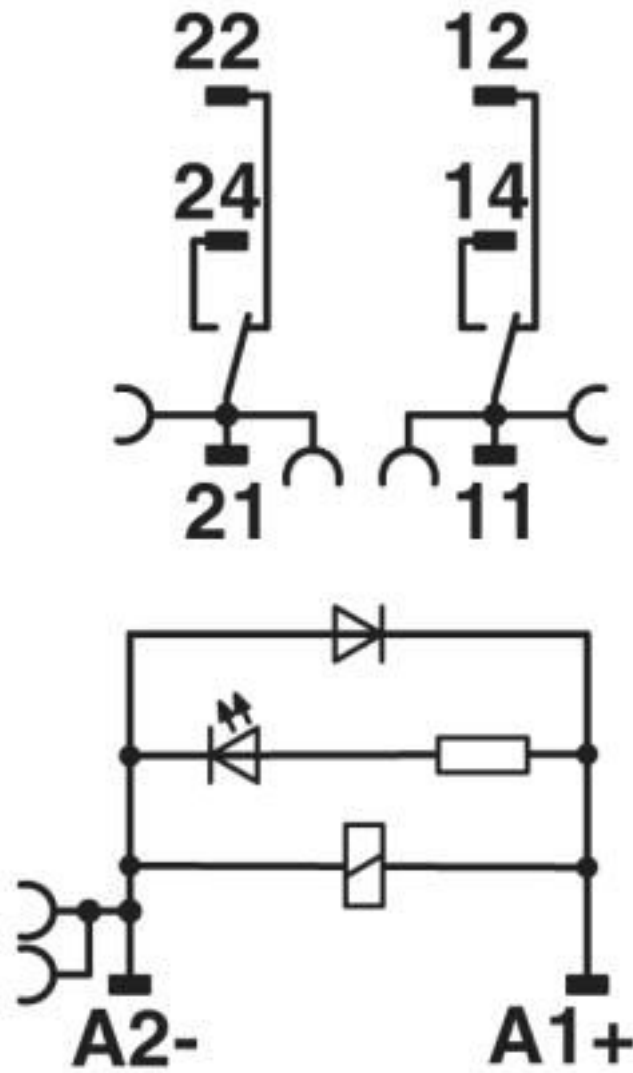

DC coils

Relay Module - RIF-1-RSC-LDP-24DC/2X21MS - 2905660

Diagram

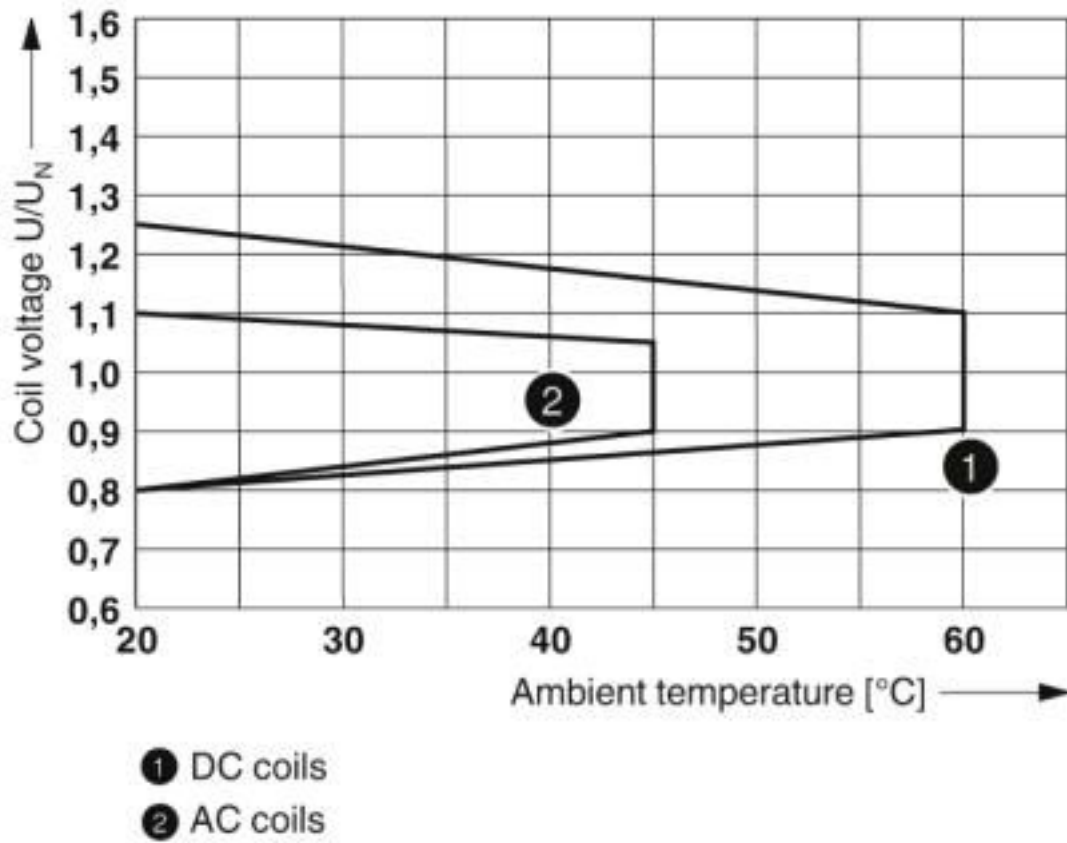

Operating voltage range

Relay Module - RIF-1-RSC-LDP-24DC/2X21MS - 2905660

Diagram

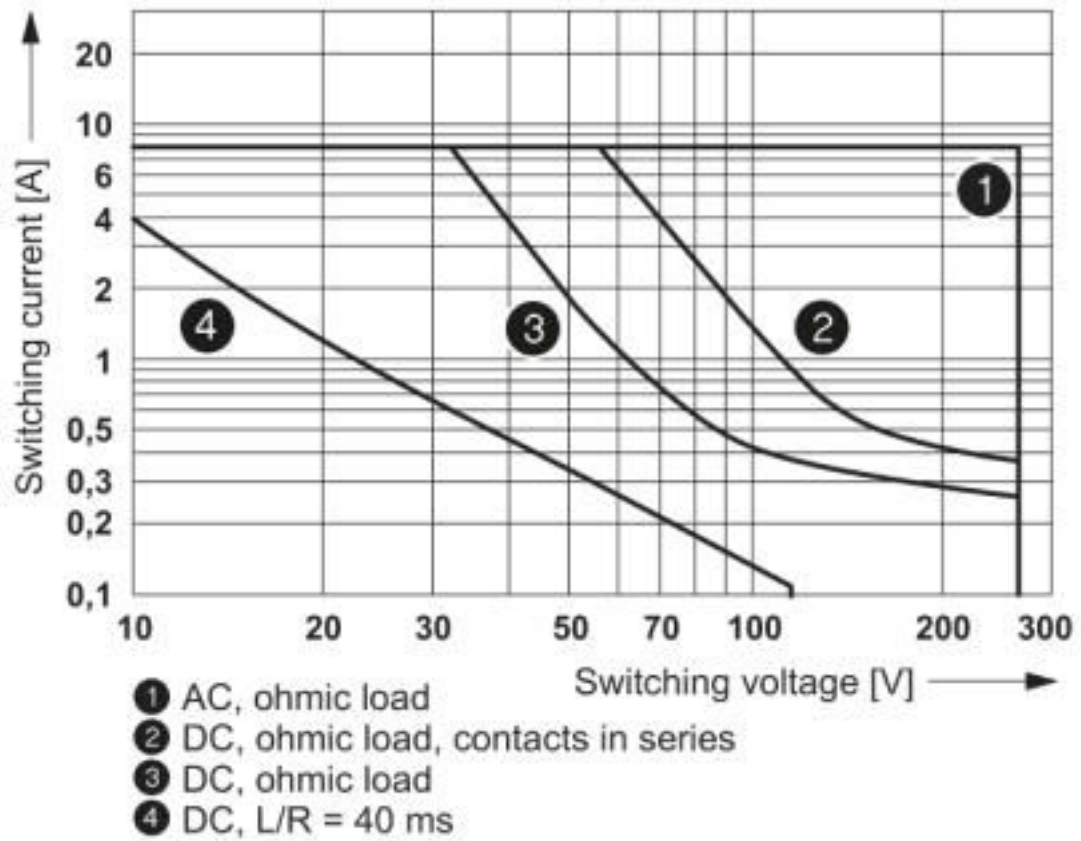

Interrupting rating

Relay Module - RIF-1-RSC-LDP-24DC/2X21MS - 2905660

Diagram

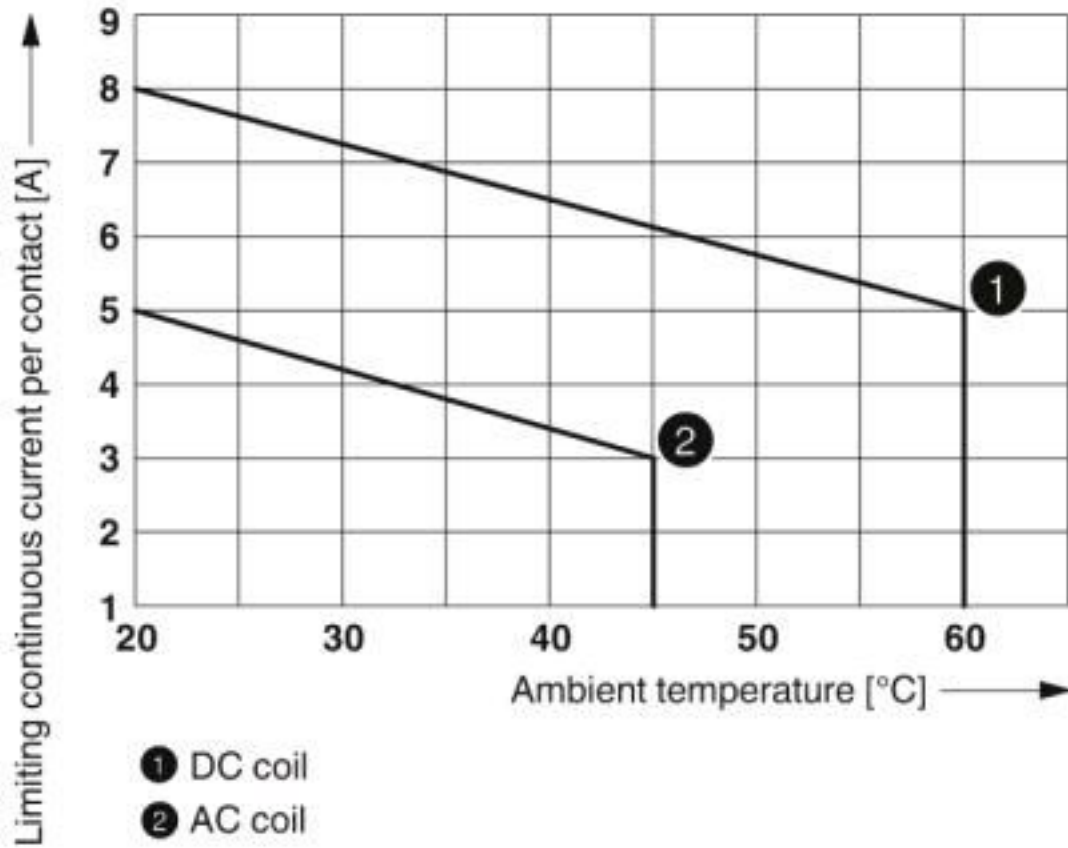

Contact derating

Relay Module - RIF-1-RSC-LDP-24DC/2X21MS - 2905660

Diagram

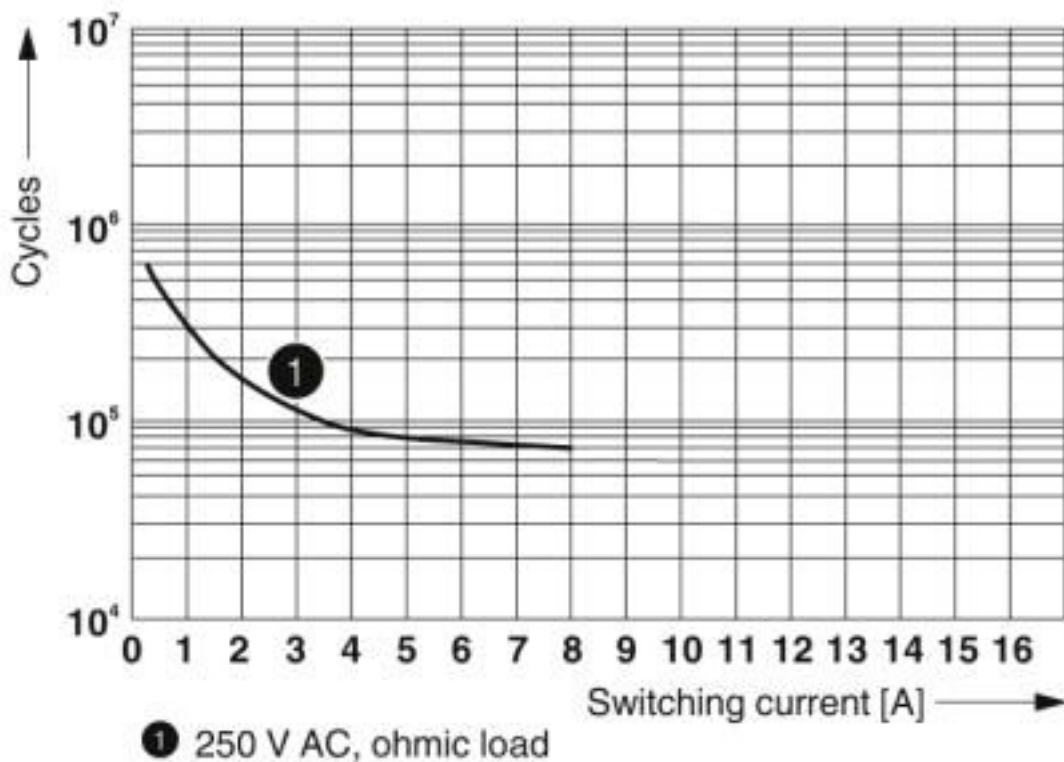

Electrical service life

Diagram

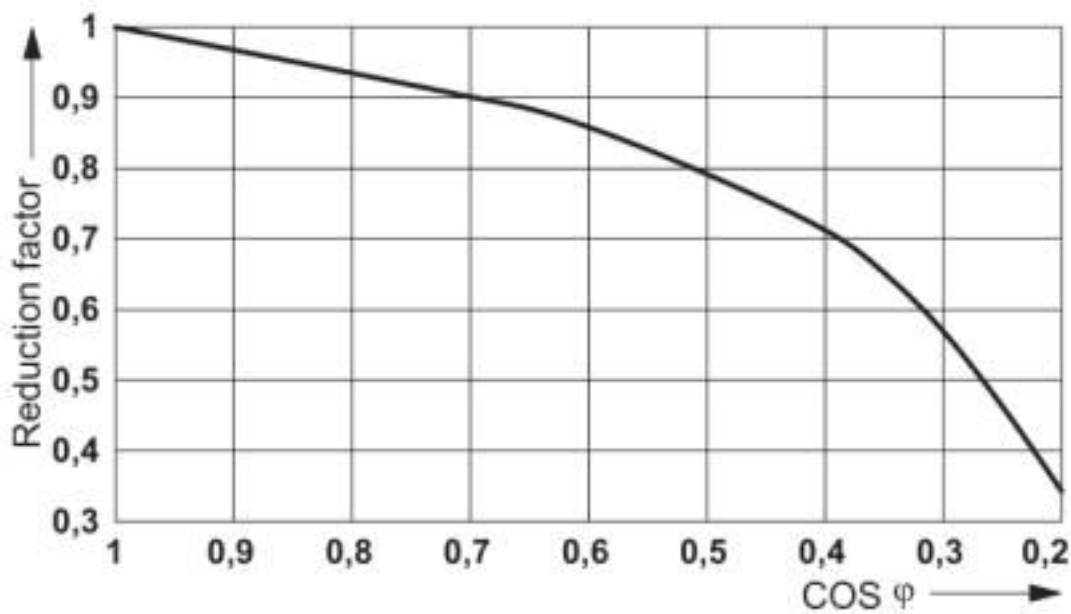

Service life reduction factor

Relay Module - RIF-1-RSC-LDP-24DC/2X21MS - 2905660

Articles in set

Relay base - RIF-1-BSC/2X21 - 2900930



RIF-1... relay base, for miniature power relay with 1 or 2 changeover contacts or identical solid-state relays, screw connection, plug-in option for input/interference suppression modules, for mounting on NS 35/7,5

Single relay - REL-MR- 24DC/21-21/MS - 2987943



Plug-in miniature relay, with power contact, 2 PDTs, test button, mechanical switch position indicator, status LED, freewheeling diode, polarity A1+, A2, input voltage 24 V DC

Retaining bracket - RIF-RH-1-H - 2904468



Relay retaining bracket, with ejector function and holder for marking material, suitable for RIF-1 relay base, for 25 mm tall miniature power relay and solid-state relay

Classifications

eCl@ss

| | |
|---------------|----------|
| eCl@ss 10.0.1 | 27371601 |
| eCl@ss 11.0 | 27371601 |
| eCl@ss 5.0 | 27371600 |
| eCl@ss 5.1 | 27371600 |
| eCl@ss 6.0 | 27371600 |
| eCl@ss 7.0 | 27371601 |
| eCl@ss 8.0 | 27371601 |
| eCl@ss 9.0 | 27371601 |

ETIM

| | |
|----------|----------|
| ETIM 2.0 | EC001437 |
| ETIM 3.0 | EC001437 |
| ETIM 4.0 | EC001437 |
| ETIM 5.0 | EC001437 |
| ETIM 6.0 | EC001437 |
| ETIM 7.0 | EC001437 |

Relay Module - RIF-1-RSC-LDP-24DC/2X21MS - 2905660

Classifications

UNSPSC

| | |
|-------------|----------|
| UNSPSC 13.2 | 39122334 |
| UNSPSC 18.0 | 39122334 |
| UNSPSC 19.0 | 39122334 |
| UNSPSC 20.0 | 39122334 |
| UNSPSC 21.0 | 39122334 |

Approvals

Approvals

Approvals

DNV GL / EAC

Ex Approvals

Approval details

| | | | |
|--------|---|---|------------|
| DNV GL |  | https://approvalfinder.dnvgl.com/ | TAA000018V |
|--------|---|---|------------|

| | | | |
|-----|---|--|-----------------|
| EAC |  | | TR_TS_D_00573_c |
|-----|---|--|-----------------|

Accessories

Accessories

DIN rail

DIN rail perforated - NS 35/ 7,5 PERF 2000MM - 0801733



DIN rail perforated, Standard profile, width: 35 mm, height: 7.5 mm, acc. to EN 60715, material: Steel, galvanized, passivated with a thick layer, length: 2000 mm, color: silver

Relay Module - RIF-1-RSC-LDP-24DC/2X21MS - 2905660

Accessories

DIN rail, unperforated - NS 35/ 7,5 UNPERF 2000MM - 0801681



DIN rail, unperforated, Standard profile, width: 35 mm, height: 7.5 mm, acc. to EN 60715, material: Steel, galvanized, passivated with a thick layer, length: 2000 mm, color: silver

DIN rail perforated - NS 35/ 7,5 WH PERF 2000MM - 1204119



DIN rail perforated, Standard profile, width: 35 mm, height: 7.5 mm, acc. to EN 60715, material: Steel, Galvanized, white passivated, length: 2000 mm, color: silver

DIN rail, unperforated - NS 35/ 7,5 WH UNPERF 2000MM - 1204122



DIN rail, unperforated, Standard profile, width: 35 mm, height: 7.5 mm, acc. to EN 60715, material: Steel, Galvanized, white passivated, length: 2000 mm, color: silver

DIN rail, unperforated - NS 35/ 7,5 AL UNPERF 2000MM - 0801704



DIN rail, unperforated, Standard profile, width: 35 mm, height: 7.5 mm, acc. to EN 60715, material: Aluminum, uncoated, length: 2000 mm, color: silver

DIN rail perforated - NS 35/ 7,5 ZN PERF 2000MM - 1206421



DIN rail perforated, Standard profile, width: 35 mm, height: 7.5 mm, acc. to EN 60715, material: Steel, galvanized, length: 2000 mm, color: silver

Relay Module - RIF-1-RSC-LDP-24DC/2X21MS - 2905660

Accessories

DIN rail, unperforated - NS 35/ 7,5 ZN UNPERF 2000MM - 1206434



DIN rail, unperforated, Standard profile, width: 35 mm, height: 7.5 mm, acc. to EN 60715, material: Steel, galvanized, length: 2000 mm, color: silver

DIN rail, unperforated - NS 35/ 7,5 CU UNPERF 2000MM - 0801762



DIN rail, unperforated, Standard profile, width: 35 mm, height: 7.5 mm, acc. to EN 60715, material: Copper, uncoated, length: 2000 mm, color: copper-colored

End cap - NS 35/ 7,5 CAP - 1206560



DIN rail end piece, for DIN rail NS 35/7.5

DIN rail perforated - NS 35/15 PERF 2000MM - 1201730



DIN rail perforated, Standard profile, width: 35 mm, height: 15 mm, similar to EN 60715, material: Steel, galvanized, passivated with a thick layer, length: 2000 mm, color: silver

DIN rail, unperforated - NS 35/15 UNPERF 2000MM - 1201714



DIN rail, unperforated, Standard profile, width: 35 mm, height: 15 mm, similar to EN 60715, material: Steel, galvanized, passivated with a thick layer, length: 2000 mm, color: silver

Relay Module - RIF-1-RSC-LDP-24DC/2X21MS - 2905660

Accessories

DIN rail perforated - NS 35/15 WH PERF 2000MM - 0806602



DIN rail perforated, Standard profile, width: 35 mm, height: 15 mm, similar to EN 60715, material: Steel, Galvanized, white passivated, length: 2000 mm, color: silver

DIN rail, unperforated - NS 35/15 WH UNPERF 2000MM - 1204135



DIN rail, unperforated, Standard profile, width: 35 mm, height: 15 mm, similar to EN 60715, material: Steel, Galvanized, white passivated, length: 2000 mm, color: silver

DIN rail, unperforated - NS 35/15 AL UNPERF 2000MM - 1201756



DIN rail, unperforated, Standard profile, width: 35 mm, height: 15 mm, similar to EN 60715, material: Aluminum, uncoated, length: 2000 mm, color: silver

DIN rail perforated - NS 35/15 ZN PERF 2000MM - 1206599



DIN rail perforated, Standard profile, width: 35 mm, height: 15 mm, similar to EN 60715, material: Steel, galvanized, length: 2000 mm, color: silver

DIN rail, unperforated - NS 35/15 ZN UNPERF 2000MM - 1206586



DIN rail, unperforated, Standard profile, width: 35 mm, height: 15 mm, similar to EN 60715, material: Steel, galvanized, length: 2000 mm, color: silver

Relay Module - RIF-1-RSC-LDP-24DC/2X21MS - 2905660

Accessories

DIN rail, unperforated - NS 35/15 CU UNPERF 2000MM - 1201895



DIN rail, unperforated, Standard profile, width: 35 mm, height: 15 mm, similar to EN 60715, material: Copper, uncoated, length: 2000 mm, color: copper-colored

End cap - NS 35/15 CAP - 1206573



DIN rail end piece, for DIN rail NS 35/15

DIN rail, unperforated - NS 35/15-2,3 UNPERF 2000MM - 1201798



DIN rail, unperforated, Standard profile 2.3 mm, width: 35 mm, height: 15 mm, acc. to EN 60715, material: Steel, galvanized, passivated with a thick layer, length: 2000 mm, color: silver

End block

End clamp - CLIPFIX 35 - 3022218



Quick mounting end clamp for NS 35/7,5 DIN rail or NS 35/15 DIN rail, with marking option, width: 9.5 mm, color: gray

End clamp - CLIPFIX 35-5 - 3022276



Quick mounting end clamp for NS 35/7,5 DIN rail or NS 35/15 DIN rail, with marking option, with parking option for FBS...5, FBS...6, KSS 5, KSS 6, width: 5.15 mm, color: gray

Relay Module - RIF-1-RSC-LDP-24DC/2X21MS - 2905660

Accessories

End clamp - E/NS 35 N - 0800886



End clamp, width: 9.5 mm, color: gray

Insulating sleeve

Insulating sleeve - MPS-IH WH - 0201663



Insulating sleeve, color: white

Insulating sleeve - MPS-IH RD - 0201676



Insulating sleeve, color: red

Insulating sleeve - MPS-IH BU - 0201689



Insulating sleeve, color: blue

Insulating sleeve - MPS-IH YE - 0201692



Insulating sleeve, color: yellow

Relay Module - RIF-1-RSC-LDP-24DC/2X21MS - 2905660

Accessories

Insulating sleeve - MPS-IH GN - 0201702

Insulating sleeve, color: green



Insulating sleeve - MPS-IH GY - 0201728

Insulating sleeve, color: gray



Insulating sleeve - MPS-IH BK - 0201731

Insulating sleeve, color: black



Jumper

Plug-in bridge - FBS 2-6 - 3030336



Plug-in bridge, pitch: 6.2 mm, width: 10.7 mm, number of positions: 2, color: red

Plug-in bridge - FBS 2-6 BU - 3036932



Plug-in bridge, pitch: 6.2 mm, width: 10.7 mm, number of positions: 2, color: blue

Relay Module - RIF-1-RSC-LDP-24DC/2X21MS - 2905660

Accessories

Plug-in bridge - FBS 2-6 GY - 3032237



Plug-in bridge, pitch: 6.2 mm, width: 10.7 mm, number of positions: 2, color: gray

Plug-in bridge - FBS 2-8 - 3030284



Plug-in bridge, pitch: 8.2 mm, width: 14.7 mm, number of positions: 2, color: red

Plug-in bridge - FBS 2-8 BU - 3032567



Plug-in bridge, pitch: 8.2 mm, width: 14.7 mm, number of positions: 2, color: blue

Plug-in bridge - FBS 2-8 GY 7042 - 3032541



Bridge for potential distribution

Labeled terminal marker

Zack marker strip - ZB 5 CUS - 0824962



Zack marker strip, can be ordered: Strip, white, labeled according to customer specifications, mounting type: snap into tall marker groove, for terminal block width: 5.2 mm, lettering field size: 5.15 x 10.5 mm, Number of individual labels: 10

Relay Module - RIF-1-RSC-LDP-24DC/2X21MS - 2905660

Accessories

Zack marker strip - ZB 5,LGS:FORTL.ZAHLEN - 1050017



Zack marker strip, Strip, white, labeled, printed horizontally: consecutive numbers 1 ... 10, 11 ... 20, etc. up to 491 ... 500, mounting type: snap into tall marker groove, for terminal block width: 5.2 mm, lettering field size: 5.15 x 10.5 mm, Number of individual labels: 10

Zack marker strip - ZB 5,QR:FORTL.ZAHLEN - 1050020



Zack marker strip, white, Printed vertically: consecutive numbers 1 ... 10, 11 ... 20, etc. up to 491 ... 500, mounting type: snap into tall marker groove, for terminal block width: 5.2 mm, lettering field size: 5.15 x 10.5 mm

Zack marker strip - ZB 5,LGS:GLEICHE ZAHLEN - 1050033



Zack marker strip, Strip, white, labeled, can be labeled with: CMS-P1-PLOTTER, printed horizontally: Identical numbers 1 or 2, etc. up to 100, mounting type: snap into tall marker groove, for terminal block width: 5.2 mm, lettering field size: 5.15 x 10.5 mm, Number of individual labels: 10

Zack marker strip - ZB 5,LGS:L1-N,PE - 1050415



Zack marker strip, Strip, white, labeled, horizontal: L1, L2, L3, N, PE, L1, L2, L3, N, PE, mounting type: snap into tall marker groove, for terminal block width: 5.2 mm, lettering field size: 5.15 x 10.5 mm, Number of individual labels: 10

Marker for terminal blocks - UC-TM 5 CUS - 0824581



Marker for terminal blocks, can be ordered: by sheet, white, labeled according to customer specifications, mounting type: snap into tall marker groove, for terminal block width: 5.2 mm, lettering field size: 10.5 x 4.6 mm, Number of individual labels: 96

Relay Module - RIF-1-RSC-LDP-24DC/2X21MS - 2905660

Accessories

Marker for terminal blocks - UCT-TM 5 CUS - 0829595



Marker for terminal blocks, can be ordered: by sheet, white, labeled according to customer specifications, mounting type: snap into tall marker groove, for terminal block width: 5.2 mm, lettering field size: 4.6 x 10.5 mm, Number of individual labels: 72

Zack marker strip - ZB 15 CUS - 0824945



Zack marker strip, can be ordered: Strip, white, labeled according to customer specifications, mounting type: snap into tall marker groove, for terminal block width: 15.2 mm, lettering field size: 10.5 x 15.1 mm, Number of individual labels: 5

Zack marker strip - ZB 15,LGS:L1-N,PE - 0811998



Zack marker strip, Strip, white, labeled, printed horizontally: L1, L2, L3, N, PE, mounting type: snap into tall marker groove, for terminal block width: 15.2 mm, lettering field size: 10.5 x 15.1 mm, Number of individual labels: 5

Marker carriers

Marker carriers - STP 5-2 - 0800967



Double marker carrier, snaps onto the double-level spring-cage terminal block STTB 2,5, STTB 4, PTTB 2,5, PTTB 4 can be marked with UC-TM 5, ZB 5 or UC-TMF 5, ZBF 5

Terminal marking

Marker for terminal blocks - UC-TM 16 - 0819217



Marker for terminal blocks, Sheet, white, unlabeled, can be labeled with: BLUEMARK ID COLOR, BLUEMARK ID, BLUEMARK CLED, PLOTMARK, CMS-P1-PLOTTER, mounting type: snap into tall marker groove, for terminal block width: 16 mm, lettering field size: 15.45 x 10.5 mm, Number of individual labels: 32

Relay Module - RIF-1-RSC-LDP-24DC/2X21MS - 2905660

Accessories

Marker for terminal blocks - UC-TMF 16 - 0819262



Marker for terminal blocks, Sheet, white, unlabeled, can be labeled with: BLUEMARK ID COLOR, BLUEMARK ID, BLUEMARK CLED, PLOTMARK, CMS-P1-PLOTTER, mounting type: snap into flat marker groove, for terminal block width: 16 mm, lettering field size: 15.45 x 5.1 mm, Number of individual labels: 32

Zack marker strip - ZB 5 :UNBEDRUCKT - 1050004



Zack marker strip, Strip, white, unlabeled, can be labeled with: PLOTMARK, CMS-P1-PLOTTER, mounting type: snap into tall marker groove, for terminal block width: 5.2 mm, lettering field size: 5.1 x 10.5 mm, Number of individual labels: 10

Marker for terminal blocks - UC-TM 5 - 0818108



Marker for terminal blocks, Sheet, white, unlabeled, can be labeled with: BLUEMARK ID COLOR, BLUEMARK ID, BLUEMARK CLED, PLOTMARK, CMS-P1-PLOTTER, mounting type: snap into tall marker groove, for terminal block width: 5.2 mm, lettering field size: 10.5 x 4.6 mm, Number of individual labels: 96

Marker for terminal blocks - UCT-TM 5 - 0828734



Marker for terminal blocks, Sheet, white, unlabeled, can be labeled with: TOPMARK NEO, TOPMARK LASER, BLUEMARK ID COLOR, BLUEMARK ID, BLUEMARK CLED, THERMOMARK PRIME, THERMOMARK CARD 2.0, THERMOMARK CARD, mounting type: snap into tall marker groove, for terminal block width: 5.2 mm, lettering field size: 4.6 x 10.5 mm, Number of individual labels: 72

Zack marker strip - ZB 15:UNBEDRUCKT - 0811972



Zack marker strip, Strip, white, unlabeled, can be labeled with: PLOTMARK, CMS-P1-PLOTTER, mounting type: snap into tall marker groove, for terminal block width: 15.2 mm, lettering field size: 10.5 x 15.1 mm, Number of individual labels: 5

Test plug terminal block

Relay Module - RIF-1-RSC-LDP-24DC/2X21MS - 2905660

Accessories

Test plugs - MPS-MT - 0201744



Test plugs, with solder connection up to 1 mm² conductor cross section, color: gray

Spare parts

Relay base - RIF-1-BSC/2X21 - 2900930



RIF-1... relay base, for miniature power relay with 1 or 2 changeover contacts or identical solid-state relays, screw connection, plug-in option for input/interference suppression modules, for mounting on NS 35/7,5

Single relay - REL-MR- 24DC/21-21/MS - 2987943



Plug-in miniature relay, with power contact, 2 PDTs, test button, mechanical switch position indicator, status LED, freewheeling diode, polarity A1+, A2, input voltage 24 V DC

Retaining bracket - RIF-RH-1-H - 2904468



Relay retaining bracket, with ejector function and holder for marking material, suitable for RIF-1 relay base, for 25 mm tall miniature power relay and solid-state relay